

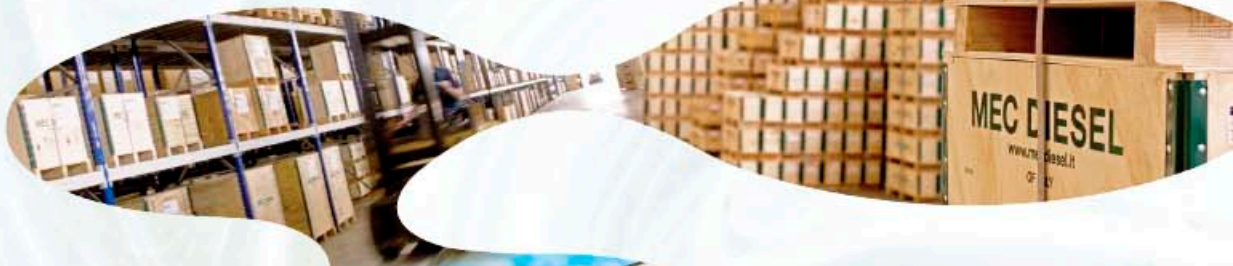

Edizione / *Edition* 2017

1.3 Multijet

www.mecdiesel.it



MEC DIESEL CAMBIA LOOK

A BRAND NEW LOOK FOR MEC DIESEL PRODUCTS

Nuova veste grafica e qualità imballo sempre più alta per proteggere i prodotti distribuiti in tutto il mondo

New packaging graphics and higher quality to protect the products distributed all over the world

Etichette con codici a barre per una gestione degli articoli rapida ed efficiente

Labels with barcodes for quick and efficient items management



La **MEC DIESEL** da sempre è attenta alla cura dei dettagli, proprio per questo ha deciso di rinnovare la grafica e la qualità del packaging.

I prodotti Mec Diesel, con oltre 40.000 spedizioni annue, sono distribuiti in tutto il mondo in tempi brevi, grazie alla collaborazione con le maggiori aziende di logistica nazionali ed internazionali.

MEC DIESEL has always paid attention to the details, this is the reason why we have decided to renovate packaging graphics and quality.

Mec Diesel products, with more than 40.000 shipments per year, are distributed all over the world in a short time, thanks to the collaboration with the most important national and international logistics companies.



Product line

MEC DIESEL S.p.A, leader nel settore dei componenti motore, nell'ottica di fornire un servizio completo nei confronti dei suoi clienti, mette a disposizione l'intera gamma di prodotti necessari per il ripristino del motore **1.3 MultiJet**.

I componenti proposti sono raccolti per semplificare la ricerca su di un unico catalogo dedicato, riportando riferimenti OEM, riferimenti Mec Diesel, descrizioni, applicazioni, tipo motore e specifiche tecniche, fornendo i dati necessari per identificare il corretto particolare e garantire la miglior funzionalità del motore stesso.

La MEC DIESEL S.p.A, da sempre attenta alle esigenze di mercato, vi ringrazia per la collaborazione in termini di segnalazioni, necessarie per l'aggiornamento gamma prodotti.

MEC DIESEL S.p.A.



MEC DIESEL S.p.A, the engine spare parts leader, in order to provide a complete service to its customers, offers a full range of products required to rebuilt 1.3 MultiJet engines.

This catalogue is meant to simplify products requests for our Valued Customers, providing OEM references, Mec Diesel references, descriptions, applications, engine types and technical specifications, in order to identify the correct spare part and ensure the best functionality of the engine.

MEC DIESEL S.p.A, always focused on market's needs, thanks you in advance for your co-operation required to update the product lines.

MEC DIESEL S.p.a.



MOTORE 1.3 MJTD

Engine 1.3 MJTD



Motori completi e semicompleti
Engines and longblocks

APPLICAZIONI

Application

FIAT
ALFA ROMEO
LANCIA
OPEL
FORD
CHEVROLET
SUZUKI

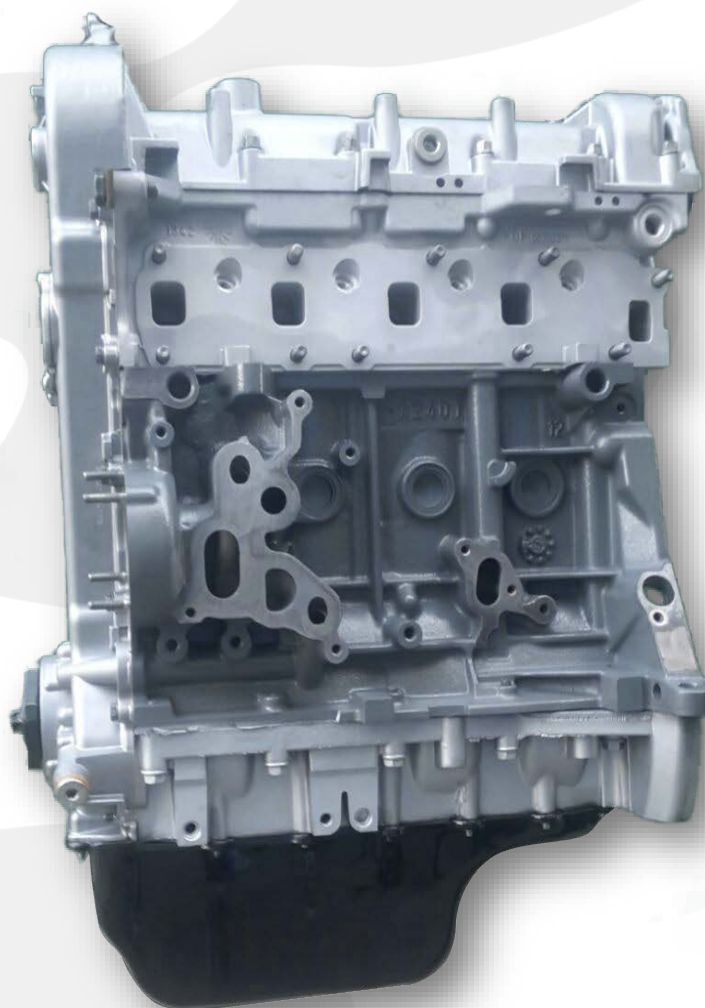

Contatta il tuo commerciale per la gamma completa e i prezzi netti a te dedicati.

Contact sales department for the complete product line and for your net prices.

* I riferimenti originali e le immagini sono riportati unicamente a titolo indicativo * The OE references and pictures are given for the purpose of explanation only *

ALBERO MOTORE 1.3 MJTD



1.3 MJTD Crankshaft

ALBERO MOTORE NUOVO

NEW Crankshaft

MEC 10170

OE 55200308



Contatta il tuo commerciale per la disponibilità e i prezzi netti a te dedicati.

Contact sales department for availability and for your net prices.

* I riferimenti originali e le immagini sono riportati unicamente a titolo indicativo * The OE references and pictures are given for the purpose of explanation only *

MEC 852230



Segmenti – Piston rings

KS814440 – 2 mm / 1,5 mm / 2 mm

814480 – 1,5 mm / 1,5 mm / 2 mm

Ø 69,6 – vaschetta D. 37 – senza gallerie

Ø 69,6 – bowl D. 37 – without oil cooler duct

OE FIAT 55200302, 55180966, 71729500

Tipo motore 188A8000, 188A9000, 199A2000
Engine type

MEC 852234



Ø 69,6 + 0,4 – vaschetta D. 37 – senza gallerie

Ø 69,6 + 0,4 – bowl D. 37 – without oil cooler duct

OE FIAT 55197998, 55196817

OE OPEL 623582, 93192653

Tipo motore 188A8000, 188A9000, 199A2000
Engine type

MEC 852236



Ø 69,6 + 0,6 – vaschetta D. 37 – senza gallerie

Ø 69,6 + 0,6 – bowl D. 37 – without oil cooler duct

OE FIAT 55197998/60, 71711498

Tipo motore 188A8000, 188A9000, 199A2000
Engine type

MEC 852240



Segmenti – Piston rings

KS814440 – 2 mm / 1,5 mm / 2 mm

814480 – 1,5 mm / 1,5 mm / 2 mm

Ø 69,6 – vaschetta D. 38 – con gallerie

Ø 69,6 – bowl D. 38 – with oil cooler duct

OE FIAT 55223520, 55197996, 55197998, 71738447

OE OPEL 623534, 93184171

Tipo motore 169A1000, 199A3000
Engine type

MEC 852244



Ø 69,6 + 0,4 – vaschetta D. 38 – con gallerie

Ø 69,6 + 0,4 – bowl D. 38 – with oil cooler duct

OE FIAT 55223525, 55198008, 71748393

OE OPEL 624063

Tipo motore 169A1000, 199A3000, 199B2000, 199B4000
Engine type

* I riferimenti originali e le immagini sono riportati unicamente a titolo indicativo * The OE references and pictures are given for the purpose of explanation only *

MEC 880087

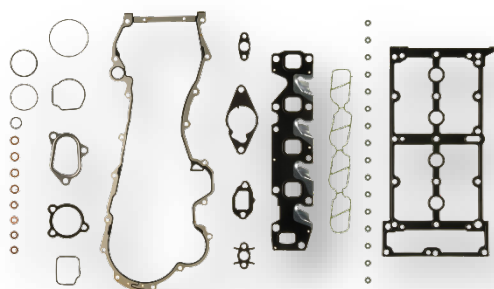

Guarnizione SMERIGLIO senza GT
Valve refacing gasket set without head gasket

OE FIAT 71729499, 71744285

Tipo motore 169A1000, 188A8000, 188A9000, 199A2000
Engine type

MEC 880088

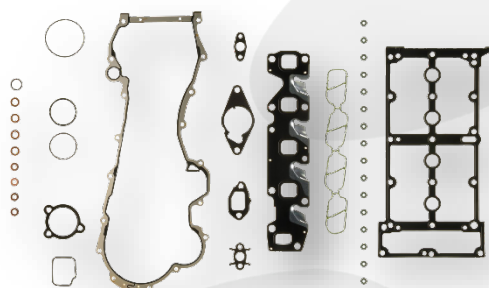

Guarnizione SMERIGLIO senza GT
Valve refacing gasket set without head gasket

OE FIAT 71744288

OE OPEL 1606455

Tipo motore 199A3000, 223A9000
Engine type

MEC 885070

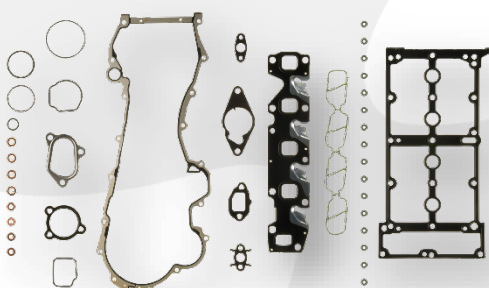

Guarnizione SMERIGLIO senza GT
Valve refacing gasket set without head gasket

OE FIAT 71753766, 71753908

OE OPEL 6606041

Tipo motore 199B1000, 169A5000, 199B4000, 223A9000, 263A2000
Engine type

MEC 920020

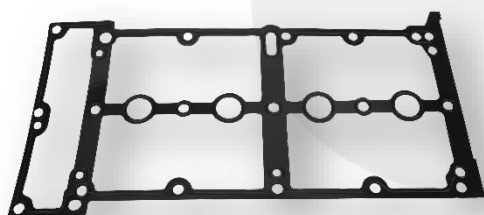

Guarnizione coperchio punterie
Valve cover gasket

OE FIAT 73500063

OE OPEL 4708530, 5607842, 93177255, 93193361

OE FORD 1563470

OE PEUGEOT 0249.G7

OE SUZUKI 11189N86J00

* I riferimenti originali e le immagini sono riportati unicamente a titolo indicativo * The OE references and pictures are given for the purpose of explanation only *

MEC 870611

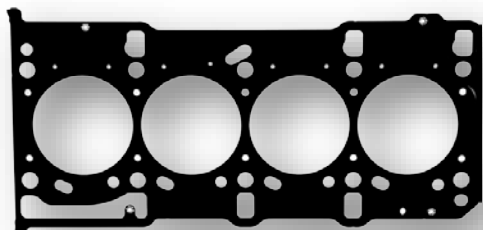

Guarnizione TESTA – senza tacche
Head gasket – without holes

OE FIAT 55209070, 55187899
OE OPEL 5607639, 5607884, 93185024

MEC 870612

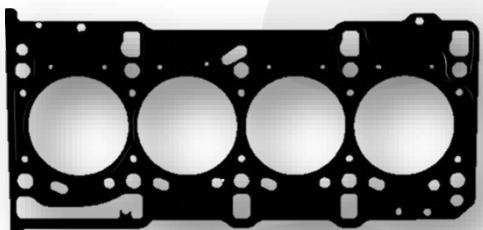

Guarnizione TESTA – 1 tacca
Head gasket – with 1 hole

OE FIAT 55187900, 55209071
OE OPEL 5607640, 5607885, 93185025

MEC 870613

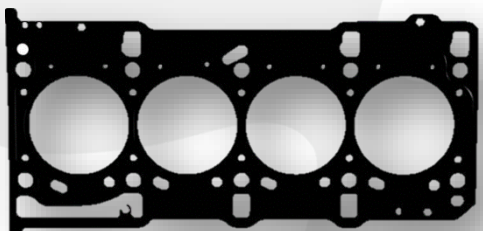

Guarnizione TESTA – 2 tacche
Head gasket – with 2 holes

OE FIAT 55187901, 55209072
OE OPEL 5607641, 5607886, 93185026

MEC 520101



Paraolio anteriore albero motore – 40 x 52 x 7
Crankshaft oil seal – 40 x 52 x 7

OE FIAT 55186757
OE OPEL 646910

* I riferimenti originali e le immagini sono riportati unicamente a titolo indicativo * The OE references and pictures are given for the purpose of explanation only *

MEC SC891250



Guarnizione COMPLEMENTARE

Gasket Set, crank case

OE FIAT 71736913, 71744286

Tipo motore 169A1000, 188A8000, 188A9000, 199A2000
Engine type

MEC SC891300



Guarnizione COMPLEMENTARE

Gasket Set, crank case

OE FIAT 71744287

OE OPEL 1606454

Tipo motore 199A3000, 223A9000
Engine type

MEC SC893180



Guarnizione COMPLEMENTARE

Gasket Set, crank case

OE FIAT 71753767

OE OPEL 6606040, 93195355

Tipo motore 199B1000, 169A5000, 199B4000, 223A9000,
Engine type 263A2000

MEC 967470

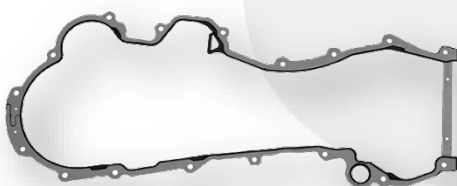

Guarnizione carter distribuzione

Gasket, timing case

OE FIAT 55186663

MEC 844760



Serie BANCO – STD

Main bearing set – STD

OE FIAT 71747643

MEC 844761



Serie BANCO + 010 / 0,25 mm

Main bearing set + 010 / 0,25 mm

OE FIAT 71747643/010

MEC 844762



Serie BANCO + 020 / 0,50 mm

Main bearing set + 020 / 0,50 mm

OE FIAT 71747643/020

MEC 844810



Serie BIELLA – STD

Conrod bearing set – STD

OE FIAT 71754218

MEC 844811



Serie BIELLA + 010 / 0,25 mm

Conrod bearing set + 010 / 0,25 mm

OE FIAT 71754218/010

MEC 844812



Serie BIELLA + 020 / 0,50 mm

Conrod bearing set + 020 / 0,50 mm

OE FIAT 71754218/020

* I riferimenti originali e le immagini sono riportati unicamente a titolo indicativo * The OE references and pictures are given for the purpose of explanation only *

MEC 101060

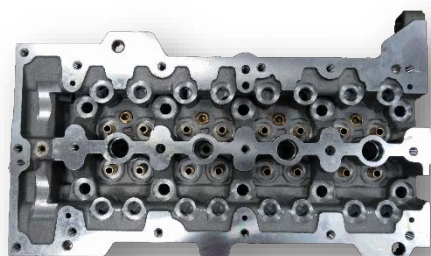

Testa cilindri – senza VALVOLE– candele M8

Cylinder Head – without valves – spark plug M8

OE FIAT 71729497, 71739601

OE OPEL 5607138, 5607170, 5607173, 5607178

Tipo motore Fiat 188A9000, 199A2000, 199A3000,
Engine type 223A9000

Opel Y13DT, Z13DT, Z13DTH, Z13DTJ

MEC 101172

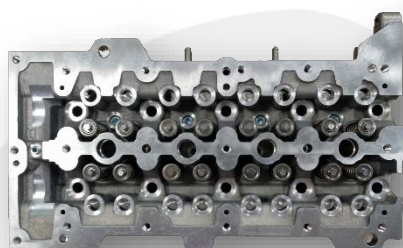

Testa cilindri – con VALVOLE – candele M9

Cylinder Head – with valves – spark plug M9

OE FIAT 71749340, 71724174

OE OPEL 55206386

Tipo motore Fiat 169A1000, 169A5000, 199A2000,
Engine type 199A3000, 199A9000, 199B1000,
199B2000, 199B4000, 263A2000

Opel Z13DTE, Z13DTJ, LDV, LSF, FHZ, F13DTE5,
D13A, A13DTC, A13DTE, A13DTR

MEC 482160



Serie viti testa 1250/1300 MJTD

Head bolt set 1250/1300 MJTD

OE FIAT 55192265

OE OPEL 4708526, 5607953, 93193361

OE FORD 1562728, 9S516065AA

OE SUZUKI 11117N86J00

MEC 22970

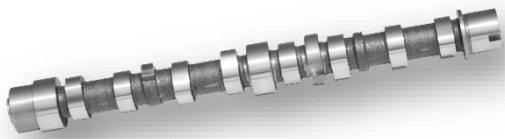

Albero di SCARICO
Exhaust camshaft

OE FIAT 46823507

OE OPEL 5636060

MEC 22990

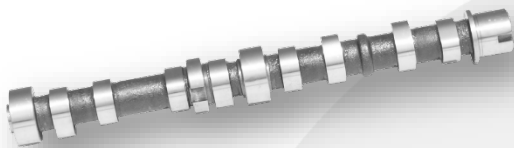

Albero di ASPIRAZIONE
Intake camshaft

OE FIAT 46823508

OE OPEL 5636059

MEC 23080

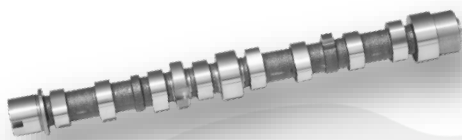

Albero di SCARICO – EURO 5
Exhaust camshaft – EURO 5

OE FIAT 55206897

MEC 23090

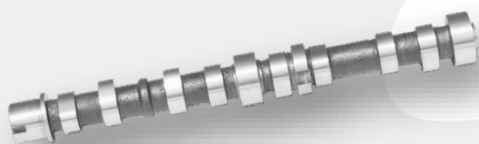

Albero di ASPIRAZIONE – EURO 5
Intake camshaft – EURO 5

OE FIAT 55206898

MEC 220080



Bicchierino/Punteria *Engine valve tappet*

OE FIAT 46475925

OE OPEL 640039, 93177316

OE SUZUKI 12891-85E00-000

MEC 170150/170151



Bilanciere/Martelletto *Rocker arm*

OE FIAT 73501138

OE OPEL 5640587

* I riferimenti originali e le immagini sono riportati unicamente a titolo indicativo * The OE references and pictures are given for the purpose of explanation only *

Kit distribuzione

Camshaft set

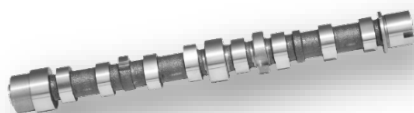

Albero di SCARICO

Exhaust camshaft

1 x MEC 22970

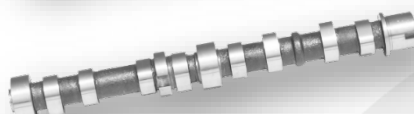

Albero di ASPIRAZIONE

Intake camshaft

1 x MEC 22990



Bicchierino/Punteria

Engine valve tappet

16 x MEC 220080



Bilanciere/Martelletto

Rocker arm

16 x MEC 170150

Kit distribuzione – EURO 5

Camshaft set – EURO 5

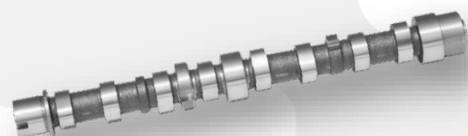

Albero di SCARICO – EURO 5

Exhaust camshaft – EURO 5

1 x MEC 23080

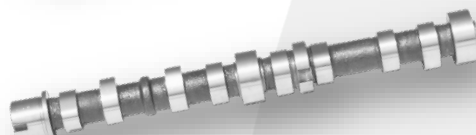

Albero di ASPIRAZIONE – EURO 5

Intake camshaft – EURO 5

1 x MEC 23090



Bicchierino/Punteria

Engine valve tappet

16 x MEC 220080



Bilanciere/Martelletto

Rocker arm

16 x MEC 170150

MEC 827060



Valvola di ASPIRAZIONE - 22 X 6 X 109.3 – 45°

Intake valve - 22 X 6 X 109.3 – 45°

OE FIAT 46518930, 55195680

OE OPEL 55219793

MEC 827070



Valvola di SCARICO - 22 X 6 X 109.3 – 45°

Exhaust valve - 22 X 6 X 109.3 – 45°

OE FIAT 46518931, 55208213, 55211867,
59116026

MEC 826970



Valvola di ASPIRAZIONE – EURO 5 - 22,4 X 6 X 109.2 - 45°

Intake valve – EURO 5 - 22,4 X 6 X 109.2 - 45°

OE OPEL 55223835, 641475, 642052, 55204574

MEC 826980



Valvola di SCARICO – EURO 5 - 22.4 X 6 X 109.3 - 45°

Exhaust valve – EURO 5 - 22.4 X 6 X 109.3 - 45°

OE OPEL 55223836, 641101

* I riferimenti originali e le immagini sono riportati unicamente a titolo indicativo * The OE references and pictures are given for the purpose of explanation only *

COPERCHI TESTA *Cylinder Head cover*



MEC 271130

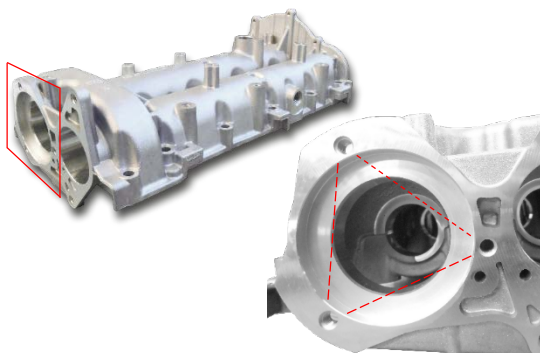

Coperchio albero distribuzione EURO 4
Cylinder Head cover EURO 4

OE FIAT 55219638

MEC 271150

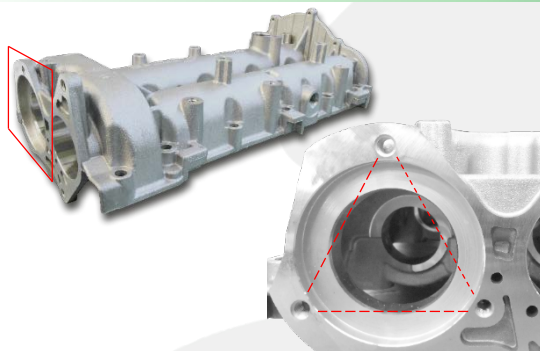

Coperchio albero distribuzione EURO 5
Cylinder Head cover EURO 5

OE FIAT 55219639

FRIZIONE *Clutch Kit*

MEC VA711140



FRIZIONE
Clutch Kit

OE FIAT 55202271, 55209831, 55210945

MEC 181810



VOLANO MONOMASSA
Flywheel

OE FIAT 55203397, 55227945

* I riferimenti originali e le immagini sono riportati unicamente a titolo indicativo * The OE references and pictures are given for the purpose of explanation only *

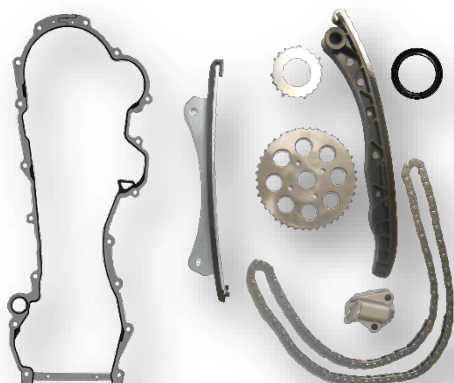

Kit catena distribuzione "8 PZ"

Distribution set "8 PCS"

OE FIAT 55195293, 55195294, 55197785, 55205447,
55205448, 55221385, 55251472, 71776647

BIELLA *Connecting rod*

MEC 40130



Biella – fratturata

Connecting rod

OE FIAT 55208624
OE OPEL 73501229

LUBRIFICAZIONE *Lubrication*

MEC KIT142800



Kit riparazione pompa olio

Oil pump repair kit

9 Componenti:

9 Components:

2 Ingranaggi kit pompa olio *2 Rotor gears*

1 Flangia di fissaggio *1 Flange for Oil pump repair kit*

1 Coperchio di chiusura *1 Oil pump cover*

5 Viti – bulloni *5 Screws - bolts*

MEC 142800



POMPA OLIO

Oil pump

OE FIAT	55232196, 55185375, 73502327
OE OPEL	646076, 93177337
OE FORD	1538742, 1723154, 9S51-6600-BA

MEC 142810



POMPA OLIO – EURO 5 – con SENSORE

Oil pump – EURO 5 - with SENSOR

OE FIAT	55233278
---------	----------

MEC 190450



Coppa OLIO

Oil sump

OE FIAT	46743794, 55197679
---------	--------------------

MEC 902400



SILICONE – Reinzosil tubo 70 ml – antracite

Silicon – Reinzosil tube 70 ml - anthracite

* I riferimenti originali e le immagini sono riportati unicamente a titolo indicativo * The OE references and pictures are given for the purpose of explanation only *

MEC 350470



POMPA ACQUA

Water pump

OE FIAT 46815125, 46819138, 71745026

OE OPEL 1334647, 6334001

MEC 930002



Termostato 88°

Thermostat 88°

OE FIAT 55180041

MEC 930020

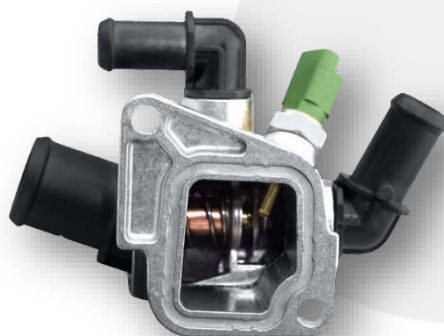

Termostato 88°

Thermostat 88°

OE FIAT 55194271, 55202373

OE OPEL 6338039, 93184200

* Per le versioni Mec-Diesel digitare il codice con la "M" finale * For the Mec-Diesel version add "M" to the part number *

MEC 341500



INIETTORE
Injector

OE FIAT 55197124, 55197875, 71794966

OE OPEL 5821097, 5821523, 93183910, 93190435

OE FORD 1538758

MEC 341490



INIETTORE
Injector

OE FIAT 55219886

MEC 341497



INIETTORE E5
Injector E5

OE FIAT 55255406

MEC 470020



OE FIAT 71772815, 55210051

OE OPEL 1826357, 55564219

* I riferimenti originali e le immagini sono riportati unicamente a titolo indicativo * The OE references and pictures are given for the purpose of explanation only *

MEC 341510



POMPA INIEZIONE

Injection pump

OE FIAT 55206489

MEC 342520



POMPA INIEZIONE

Injection pump

OE FIAT 55236707

SOVRALIMENTAZIONE *Turbocharger*

MEC 531810



TURBOSOFFIANTE

Turbocharger

OE FIAT 71724166, 71724702, 71784113, 71784115,
71794552, 73501343

OE OPEL 93191993

* I riferimenti originali e le immagini sono riportati unicamente a titolo indicativo * The OE references and pictures are given for the purpose of explanation only *

MEC 943900



VALVOLA EGR 90/95 CV
EGR Valve 90/95 CV

OE FIAT 55216292, 55252380, 71753846
OE OPEL 851045, 55577947, 5851089, 93195431

MEC 670070



VALVOLA EGR 70/75 CV
EGR Valve 70/75 CV

OE FIAT 55206931, 55219501
OE FORD AS51-9D475-AA, 1710918

MEC 670015



VALVOLA EGR 1.3 JTD
EGR Valve 1,3 JTD

OE FIAT 71769760
OE OPEL 851364, 851744, 5851049, 93177422,
93189335, 93196798

MEC 670022



VALVOLA EGR 90 CV
EGR Valve 90 CV

OE FIAT 55206932, 55219502, 71793037, 71793410

MEC 943910



RADIATORE EGR
EGR Cooler

OE FIAT 51785231
OE OPEL 851048, 851074, 55577950, 55583791

* Per le versioni Mec-Diesel digitare il codice con la "M" finale * For the Mec-Diesel version add "M" to the part number *

MEC 670430

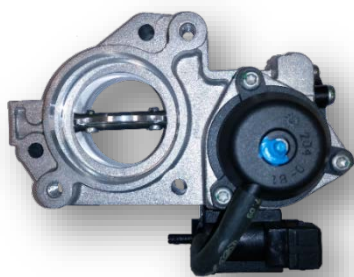

CORPO FARFALLATO

Throttle body

OE FIAT 51785231

OE OPEL 5825246, 93184874

ELETTRICO *Electric system*

MEC 332019

9 T 30/50 (Coaxial)



1.3 kW 12 V

MOTORINO DI AVVIAMENTO

Starter motor

OE FIAT 33353237, 46823548, 518102660, 51810302, 51823860, 51880229, 55204116, 55353247, 71724236, 71724238

10 T 30/50 (Coaxial)



1.4 kW 12 V

MOTORINO DI AVVIAMENTO

Starter motor

OE FIAT 51810307, 51916170

MEC 332999

Clutch pulley 6 ribs | 54 mm



90A 14 V

ALTERNATORE

Alternator

OE FIAT 46823547, 51784845, 51787208, 51787209, 51805800, 51854910, 51854914, 51854915, 55185076, 703000096

OE OPEL 13117279, 13243463, 13283344, 6204181, 6204291, 93169024, 9562205

MEC 432025

* Per le versioni Mec-Diesel digitare il codice con la "M" finale * For the Mec-Diesel version add "M" to the part number *

MEC 943040



SENSORE PRESSIONE ALIMENTAZIONE

Fuel pressure sensor

OE FIAT 504369148, 504369149, 552182980,
500303029

OE OPEL 55206797

MEC 7370007



SENSORE MASSA ARIA 1.3 MJTD

Air flow meter 1.3 MJTD

OE FIAT 51782034, 55183650, 71789484, 71793250

OE OPEL 836016, 95513367

MEC 6720037



ELETTROVALVOLA TURBOCOMPRESSORE

Pressure converter turbocharger

OE OPEL 8 51 017, 58 51 073, 58 51 600

MEC 6720062

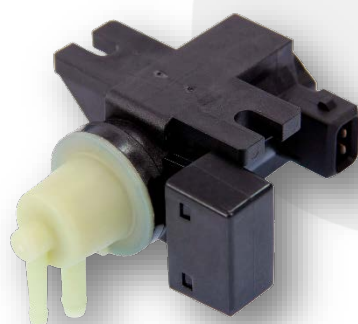

ELETTROVALVOLA TURBOCOMPRESSORE

Pressure converter turbocharger

OE FIAT 51884840, 55228986, K04627212AB

MEC 900119M



SENSORE TEMPERATURA GAS DI SCARICO

Sensor, Exhaust Gas Temperature

OE FIAT 51799538, 51825680

MEC 900124M



SENSORE TEMPERATURA GAS DI SCARICO

Sensor, Exhaust Gas Temperature

OE FIAT 55228650, 51861682

MEC 900125M



SENSORE TEMPERATURA GAS DI SCARICO

Sensor, Exhaust Gas Temperature

OE FIAT 51779770

MEC 900126M

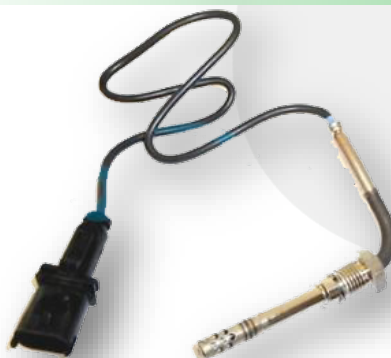

SENSORE TEMPERATURA GAS DI SCARICO

Sensor, Exhaust Gas Temperature

OE FIAT 51862720

* Per le versioni Mec-Diesel digitare il codice con la "M" finale * For the Mec-Diesel version add "M" to the part number *

MEC 900127M



SENSORE TEMPERATURA GAS DI SCARICO

Sensor, Exhaust Gas Temperature

OE FIAT 51825696, 51891442, 55234733

MEC 900128M



SENSORE TEMPERATURA GAS DI SCARICO

Sensor, Exhaust Gas Temperature

OE FIAT 51825683

MEC 900155



SENSORE PRESSIONE GAS DI SCARICO

Sensor, Exhaust Gas Pressure

OE FIAT 55198717

OE OPEL 0862715, 93187247, 93194121

OE SUZUKI 13800-T79J5, 18590-79J50, 18590-T79J5

MEC 7370070



SENSORE PRESSIONE CARBURANTE

Fuel pressure sensor

OE FIAT 55195078, 504152959

OE FORD 1547990, 1581708, 9S51-9C044-AA,
9S51-9G756-AB

OE OPEL 93185626

OE SUZUKI 15760-84E51

* Per le versioni Mec-Diesel digitare il codice con la "M" finale * For the Mec-Diesel version add "M" to the part number *

NOTE



A large area of the page is filled with horizontal dotted lines, providing a space for handwritten notes. A large, light gray abstract graphic is overlaid on the right side of this area.

MEC DIESEL: E-COMMERCE

www.mecdiesel.it

Scopri nuovi elementi di valore - *Discover better value range of product*

La Mec Diesel aperta 24 ore su 24 da pc, portatile, tablet, smartphone

*Mec Diesel available 24 hours a day
on pc, notebook, tablet, smartphone*



È noto che **MEC-DIESEL** è in grado di fornire alla clientela una gamma ed una disponibilità di componenti motore ai massimi livelli del mercato di riferimento. Partendo da questa base siamo in grado di offrire ora anche numerosi altri componenti di sistemi e apparati complementari al gruppo motopropulsore, più semplici da identificare e montare. Il nostro sito di e-commerce si sta migliorando per questo.

***MEC-DIESEL** is able to provide their customers with the product range and availability of engine components on the top level of the market.*

Besides we can offer many other components of the systems and complementary parts to the powertrain, easy to identify and to fit.

Our e-commerce is getting better for this.



CONTATTACI / CONTACT US



Via Sestriere, 3
10060 Candiolo (Torino) Italy
Tel. +39 011 3972132
Fax +39 011 3971342
www.mecdiesel.it
commerciale@mecdiesel.it
export@mecdiesel.it

Visita il nostro portale e-commerce
Visit our eCommerce website



<http://webshop.mecdiesel.it>